

Data Sheet



Article number: 20252414

Description: E+G Clamping pad
GN 709.1-20-M12-R

Measures

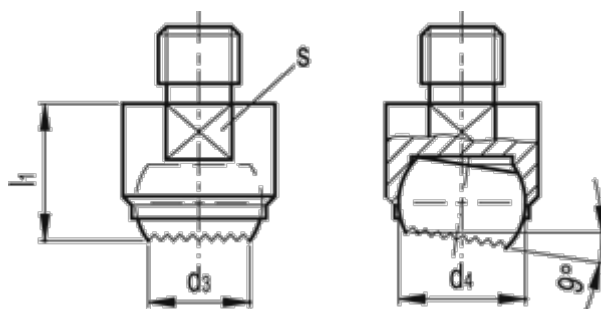

d1	= 20
d2	= M12
d3	= 10.5
d4	= 16
$l_1 \pm 0.1$	= 18
l_2	= 12
Max static load (KN)	= 25
s	= 17

Weight (g) = 40